

ENGINEERING  
TOMORROW

*Danfoss*

Product Guide

# Hydronic floor heating **Easy, proven** and **profitable**

**Easy**

selection saves time  
and increases your  
turnover.

[heating.danfoss.com](http://heating.danfoss.com)

# WE PROVIDE CONTROL EXPERTISE

**6** product areas

where hydronic control engineering results in comfort and energy saving products.

**+80** years

of experience with innovating heating control technology.

## Contents

- 4 | WHY CHOOSE DANFOSS?
- 6 | ROOM CONTROLS
- 22 | MANIFOLDS AND MIXING SHUNTS
- 34 | FLOOR HEATING PANELS
- 38 | QUALITY PIPES
- 42 | CASE STORIES

Our advanced knowledge of **hydronic control** means that you get the best products on the market.

Our knowledge of hydronic control and balancing provides you with:

- Comfort in terms of accurate temperature control
- Comfort and energy savings due to easy and accurate balancing of the heating system

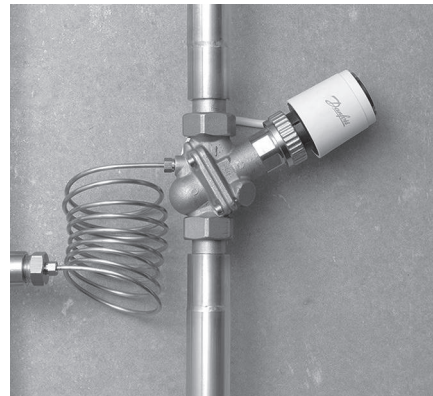

Hydronic Balancing Controls



District Heating Controls



Hydronic Floor Heating Controls



Room Controls



Radiator Controls



Cooling Controls

## TEAM UP WITH THE INVENTOR

Being the first to introduce **wireless floor heating control** is only one part of our long life within comfort control.

Danfoss has been pioneering heating control systems for more than 80 years and we have 20 years of experience in advanced wireless solutions. Throughout the years, it has been our goal to simplify both installation and operation to ensure maximum end user value and energy savings.

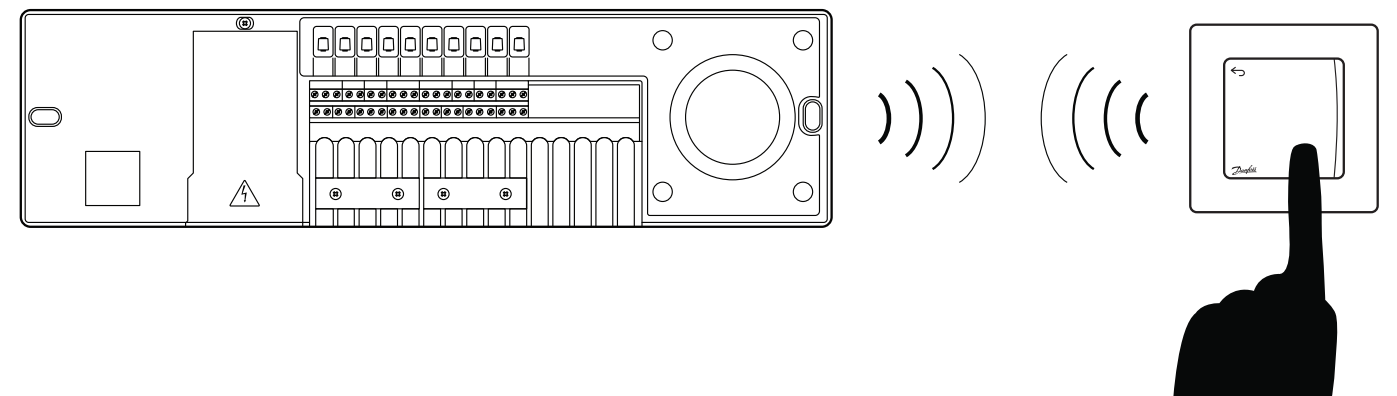
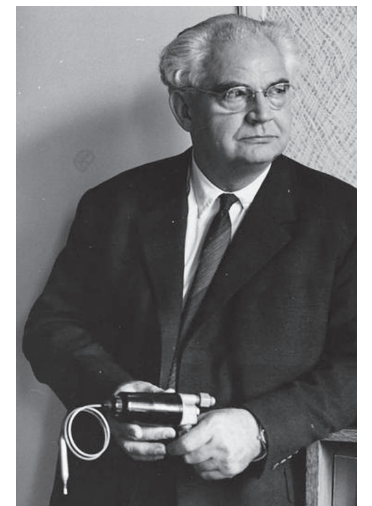





## The most advanced test center

**In Vejle, Denmark we are testing floor heating in combination with other heat emitters and heat sources while simulating outdoor temperatures.**

### **Thermal mass (Cell 1, 2 and 4)**

Houses around the world are constructed differently. Each room in the Test Center is therefore constructed with different materials and different thermal mass. The amount of thermal mass determines the heat absorbing ability of the room and thereby how fast the floor heating can heat up the room.

### **Outdoor temperature simulation (Cell 6)**

The test rooms are surrounded by a cooling zone. This enables the engineers to simulate different outdoor temperatures conditions and test how floor heating reacts under different conditions.

### **Floor heating reaction time (Cell 1, 2 and 4)**

Floor heating reacts slower than radiators. Temperature sensors are embedded in the concrete at multiple levels and vertically in the cell from floor surface to ceiling for every 0.5 m. This enables the

engineers to register the reaction time of the floor heating system.

### **Impact on the entire system (Cell 5)**

The floor heating can be connected to different heat sources such as gas boilers and district energy stations. Also, multiple heat emitters (floor heating and radiator) in the same room can be tested. This enables the engineers to assess the impact of any change on the entire system and not just on the floor heating.

### **Thermal radiation (Cell 1, 2 and 4)**

A special sensor not only measures the air temperature but also the thermal radiation from e.g. windows when it is cold outside. Thermal radiation affects comfort, which means that an air temperature of 21 °C may not feel like 21 °C.

### **Multiple rooms for testing (Cell 1, 2 and 4)**

Most test facilities use only one room. The Danfoss test facility has three rooms. This enables the engineers to test in a multi-room-system approach that is similar to a normal house.

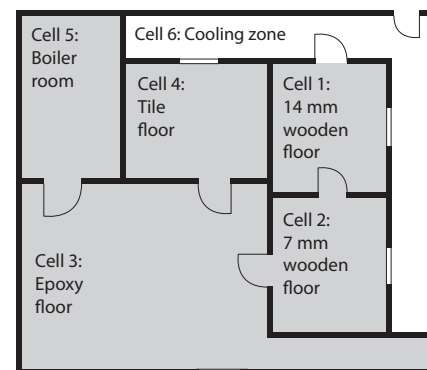

*The Test Center enables the engineers to measure the performance of the heat control system in different building constructions without any uncontrolled disturbances.*

## From specification to after-sales service We have you covered



### Before...

- Danfoss can provide all necessary components for balancing the entire system and can advise you on the optimum solution
- Danfoss offers radiator, hydronic and electrical floor heating control and can advise you about the ideal heat emitter
- Danfoss can provide written system specifications to help you with the tendering process
- Danfoss offer specialist training to ensure optimum installation results



### ...during...

- If applications change during the project, we can advise on any necessary changes
- Danfoss can help you with your first installation, thereby minimizing the risk of mistakes
- Danfoss offer full technical support. Simply call us



### ...after installation

- With over 80 years of experience, you can rely on our ongoing support
- Danfoss offer cost-free help with balancing the floor heating system correctly
- During handover, we provide all relevant material, e.g. operating instructions. This minimizes call-backs

**All products from one supplier** ensures better systems and makes your life easier.



# ROOM CONTROLS

## Product highlight: **Danfoss Link™**

### Danfoss Link™ Central Controller – intuitive touch screen and access point:

- Remote access with Danfoss Link™ App
- Makes temperature scheduling easy. Save 5% energy for every degree the room temperature can be lowered
- Adaptive learning ensures the right temperature at the right time
- Put entire heating system in 'At Home', 'Away/Asleep', 'Pause' or 'Vacation' mode from a single central point
- Wireless for easy installation
- Very accurate control with e.g. PID-controlled *living connect*® for more comfort

TIP! Ask your customers if they are interested in a smart home solution.

### Easy wireless temperature control from one access point – all around the house:

1. Danfoss Connect™  
Electronic radiator thermostat
2. Danfoss Icon™ Wireless  
Room sensor for radiator and floor  
heating control.
3. Danfoss Link™ HC  
Hydronic controller for floor heating
4. Danfoss Link™ App  
Easy temperature control from your  
smartphone

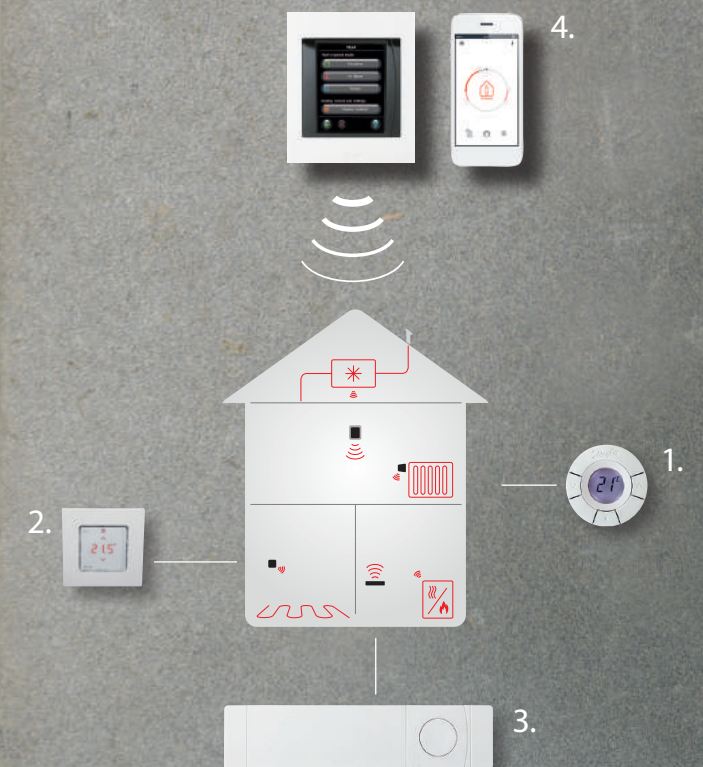

A simple  
**smart home solution**



# Product highlight: Danfoss *Icon*<sup>™</sup> Automatic balancing

## Why balance?

Water chooses the easiest path with the least resistance. In floor heating systems, the consequence is an uneven heat distribution where the shortest loop will get the most water, resulting in a faster warming of smaller rooms at the expense of the larger rooms. To achieve harmonic room temperatures, the floor heating system should be hydraulically balanced as it provides maximum comfort with minimum energy costs.



**Small rooms** with short pipes experience limited pressure losses. Therefore, the short pipe will "steal" most of the energy / water at the expense of the long pipes and will be heated quickly.

## How automatic balancing works

Based on the ability to meet the setpoint in each room, the Danfoss *Icon*<sup>™</sup> system will know the approximate size of each output (pipe length). With Danfoss *Icon*<sup>™</sup> automatic balancing, the system will reduce the "ON time" for the shorter pipes / small rooms and prioritize the longer pipes / large rooms. Thereby all rooms will get their fair ratio of the available flow when heat demand increases.

○ ON time   ● OFF time   ◐ Forced OFF time

System **without** automatic balancing when heat demand suddenly increases

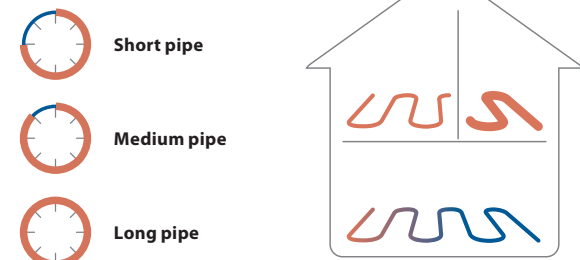

System **with** automatic balancing when heat demand suddenly increases

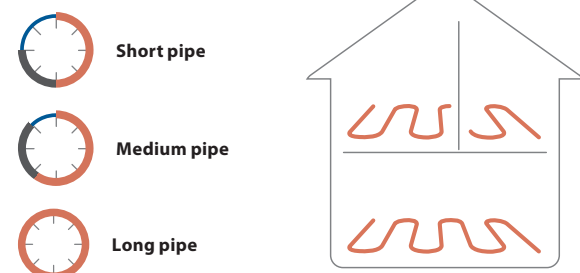

**Large rooms** with long pipes experience pressure losses. When heat demand suddenly increases the long pipes need to be prioritized at the expense of short pipes. Or else it will take too long to heat the room.

## How demand based supply temperature works

Danfoss *Icon*<sup>™</sup> 24V and wireless systems detect actual and required temperatures in each room. Based on the information, an actuator on the mixing shunt will constantly adapt the supply temperature to the actual heat demand. In effect, comfort will increase and the return temperature will decrease for improved energy efficiency.

# Product highlight: Danfoss *Icon*<sup>™</sup> Demand based supply temperature

## Why outdoor temperature compensation is not always optimal:

The supply temperature is often controlled via outdoor temperature compensation. However, outdoor temperature compensation requires wiring to an outdoor sensor and heat curve settings. Furthermore, the outdoor temperature does not necessarily reflect the actual heat demand inside of the house.

## The sun can heat up a room - even when it is cold outside.

By basing the supply temperature on the actual room demand, the Danfoss *Icon*<sup>™</sup> system takes heat from appliances, sunshine, and people in the room into account when setting the supply temperature.

The result is a comfortable and welcoming room temperature no matter the circumstances.



# WIRELESS INSTALLATION IS SIMPLE

## Installing Danfoss Icon™

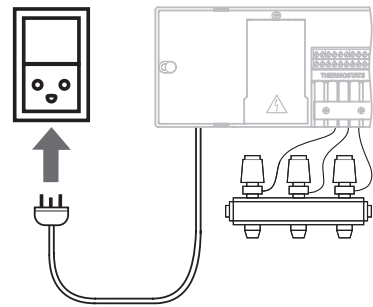

1. When all actuators are connected, connect the 24V/wireless Master Controller to the main supply.

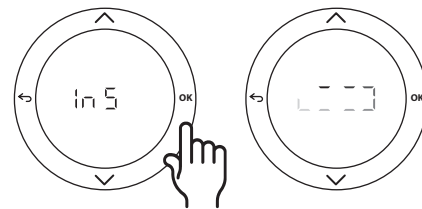

2. Make sure the Master Controller is in installation mode (Master Controller display must show "In5")
2. Press OK

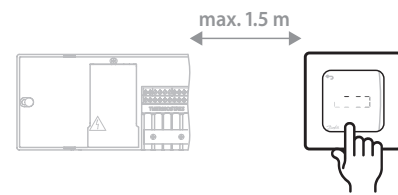

3. Swipe the room thermostat display within a distance of 1,5 meter from the radio module / Master Controller
2. When successfully connected, the room thermostat display will show a tick mark

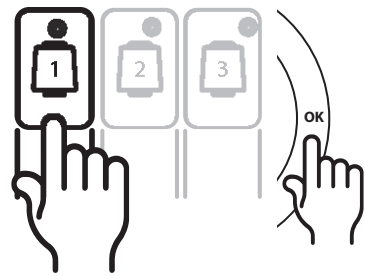

4. All outputs will flash. Press the output(s) you would like to add to the room thermostat
2. Press OK



5. Repeat steps 3-4 for each room thermostat you wish to add.

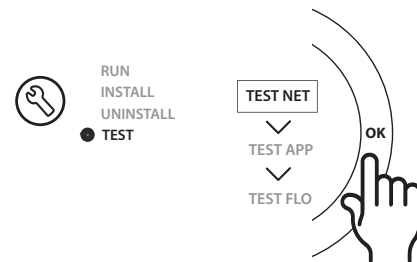

6. Place the room thermostats in the rooms
2. Perform network, application and flow test via the master controller

## Installing Danfoss Link™ CC Central Controller

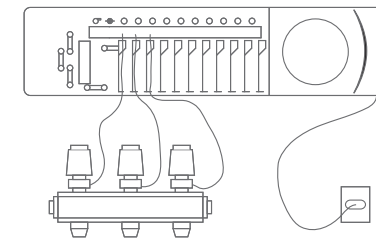

1. When all actuators are connected, connect the Danfoss Link™ HC Hydronic Controller to the main supply.

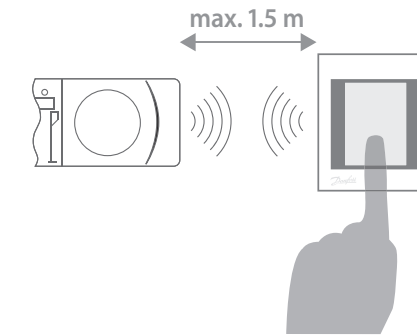

2. Add the master controller to Danfoss Link™ CC Central Controller.

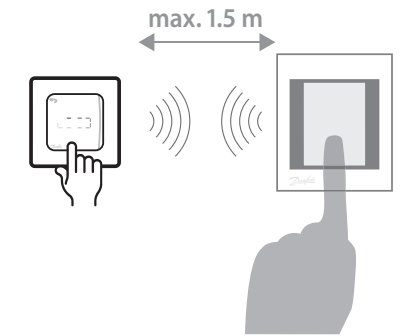

3. Add the room thermostat to Danfoss Link™ CC Central Controller.

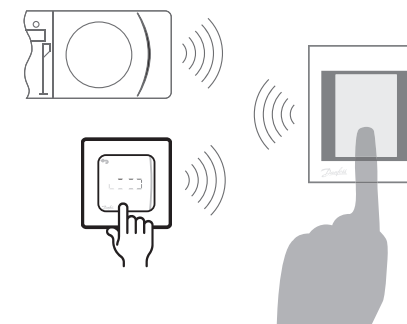

4. Pair the room thermostat with the output via Danfoss Link™ CC Central Controller.

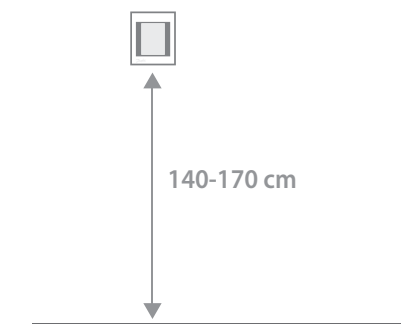

5. Install the Danfoss Link™ CC Central Controller in its final position.

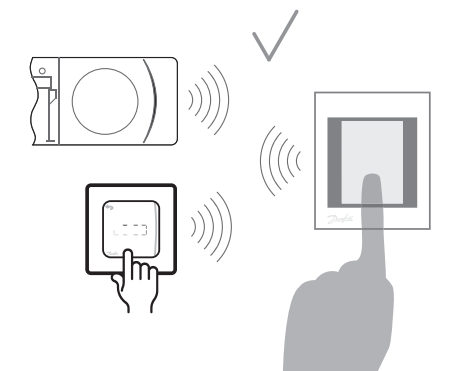

6. Perform a network test via Danfoss Link™ CC Central Controller.



# Selling system controls is good for your business and provides comfort and savings for your customers

Danfoss control solutions makes it easier for you to boost your business.

The example below is for a home where six room controls are needed.

In both cases, the manifold is a FHF and pipes are PE-RT. Room controls are CF2+ wireless system with room thermostat CF-RS.

**TIP!** Inform your customers about the comfort and energy saving benefits from using room controls.

## Typical installation **without** controls

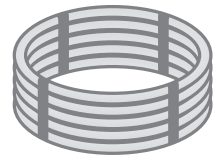
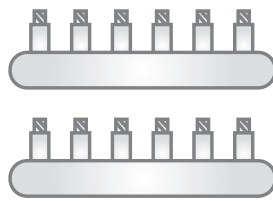

Turnover **INDEX ~40**



## Typical installation **with** controls

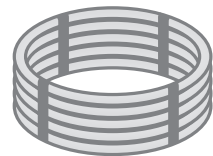
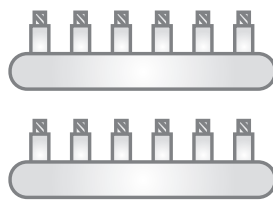

Turnover **INDEX ~100**

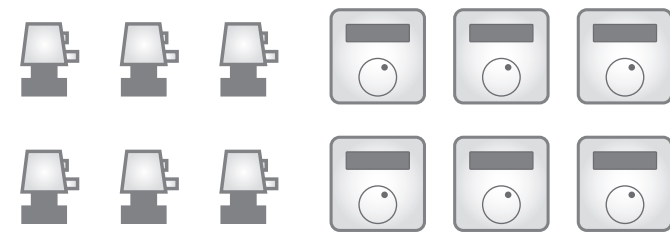

**Double your turnover** and provide comfort and energy savings for your customers.





# ROOM CONTROLS

## WHAT TO CONSIDER

1.

### BUILDING SIZE

Is the house or individual apartment larger than 300 m<sup>2</sup>?  
(Wireless range)

**NO**

**YES**

CHOOSE  
**HARDWIRED**

2.

### FLEXIBILITY

Are short installation time flexibility of placing thermostat important?

**NO**

**YES**

CHOOSE  
**WIRELESS**

3.

### COOLING

Will floor heating system be used for floor cooling?

**NO**

**YES**

CHOOSE  
**Danfoss Icon™**

4.

### BATTERIES

Is it ok that batteries need to be changed every 2 years?

**NO**

**YES**

CHOOSE  
**WIRELESS**

5.

### FEATURES

Is automatic balancing, demand based supply temperature and App required?

**NO**

CHOOSE  
**230V or  
FH-Wx 24V**

**YES**

CHOOSE  
**Danfoss  
Icon™ 24V**

## WIRELESS SOLUTIONS



### Danfoss Link™ »

The full "Smart house" solution. Can be paired with Alexa - Amazon's voice-control system. Use the both intuitive touch screen and mobile application to control both radiators and floor heating. NB: no cooling option is available, though connecting Danfoss Icon™ Wireless infrared thermostat makes possible to use infrared floor sensor.



### Danfoss Icon™ Wireless »

Designer room thermostats with automatic balancing, demand based supply temperature, App and much more.

## HARDWIRED SOLUTIONS



### Danfoss Icon™ 230 V/24V»

Designer room thermostats with multiple features.



### BasicPlus² WT-x 230 V »

Basic 230 V room thermostats.



### FH-Wx 24 V »

No electrician needed (low voltage).



# Danfoss Icon™

## 230V, 24V AND WIRELESS ROOM SYSTEMS



Room thermostats	Code no.	Fits into switch frames	Touch user interface	On-wall	In-wall	Noiseless switching	Cooling enabled	Floor sensor enabled	Scheduling	Support multiple heat emitter types	Support dual heat emitters in same room	Away input	Thermal feedback	PWM	Max actuators	Temperature limitation	NC/NO option	Valve exercise	Adaptive learning	Temperature set-back button
<b>230V</b>																				
Dial, In-wall	088U1000	✓			✓								✓		5	✓	✓			
Display, In-wall	088U1010	✓	✓		✓	✓				✓				✓	5	✓	✓	✓		
Programmable, In-wall	088U1020	✓	✓		✓	✓	✓ <sup>b</sup>	✓	✓	✓		✓		✓	5	✓	✓	✓	✓	✓
Dial, On-wall	088U1005			✓									✓		5	✓	✓			
Display, On-wall	088U1015		✓	✓		✓				✓				✓	5	✓	✓	✓		
Programmable, On-wall	088U1025		✓	✓		✓	✓ <sup>b</sup>	✓	✓	✓		✓		✓	5	✓	✓	✓	✓	✓
<b>24V</b>																				
Display, In-wall	088U1050	✓	✓		✓	✓	✓ <sup>d</sup>	✓	✓ <sup>e</sup>	✓ <sup>a</sup>	✓ <sup>a</sup>	✓ <sup>d</sup>		✓ <sup>a</sup>		✓	✓ <sup>a</sup>	✓ <sup>a</sup>	✓ <sup>e</sup>	✓ <sup>e</sup>
Display, On-wall	088U1055		✓	✓		✓	✓ <sup>d</sup>	✓	✓ <sup>e</sup>	✓ <sup>a</sup>	✓ <sup>a</sup>	✓ <sup>d</sup>		✓ <sup>a</sup>		✓	✓ <sup>a</sup>	✓ <sup>a</sup>	✓ <sup>e</sup>	✓ <sup>e</sup>
<b>Wireless</b>																				
Display, On-wall	088U1081		✓	✓		✓	✓ <sup>d</sup>		✓ <sup>e</sup>			✓ <sup>d</sup>		✓ <sup>a</sup>		✓	✓ <sup>a</sup>	✓ <sup>a</sup>	✓ <sup>e</sup>	✓ <sup>e</sup>
Infrared, On-wall	088U1082		✓	✓		✓	✓ <sup>d</sup>	✓ <sup>c</sup>	✓ <sup>e</sup>	✓ <sup>a</sup>	✓ <sup>a</sup>	✓ <sup>d</sup>		✓ <sup>a</sup>		✓	✓ <sup>a</sup>	✓ <sup>a</sup>	✓ <sup>e</sup>	✓ <sup>e</sup>

<sup>a</sup> Via master controller  
<sup>b</sup> Only 2-pipe systems.

<sup>c</sup> With build-in infrared sensor  
<sup>d</sup> Via master controller. Requires Expansion Module 088U1100

<sup>e</sup> Requires App Module 088U1101

Master controllers	Code no.	Pump relay (230V active output)	Boiler relay (potential free)	Global away input	Automatic balancing	App Control enabled	Support dual heat emitters in same room	24V wired bus communication to room thermostat	Upgradable to wireless	Supply temperature control enabled	Dew point sensor input and output (24V DC)	Cooling enabled	NC/NO option	PWM / on-off option	Support multiple heat emitter types	Channels and outputs	Max masters connected together	Valve exercise	Commissioning test
<b>230V</b>																			
8 ch., Basic	088U1030	✓	✓										NC		✓ <sup>d</sup>	8/14	3	✓ <sup>d</sup>	
8 ch., Featured	088U1031	✓	✓	✓								✓	NC		✓ <sup>d</sup>	8/14	3	✓ <sup>d</sup>	
<b>24V/wireless</b>																			
10 ch.	088U1071	✓	✓	✓ <sup>a</sup>	✓	✓ <sup>b</sup>	✓	✓	✓ <sup>e</sup>	✓ <sup>c</sup>	✓ <sup>a</sup>	✓ <sup>a</sup>	✓	✓	✓	10/10	3	✓	✓
15 ch.	088U1072	✓	✓	✓ <sup>a</sup>	✓	✓ <sup>b</sup>	✓	✓	✓ <sup>e</sup>	✓ <sup>c</sup>	✓ <sup>a</sup>	✓ <sup>a</sup>	✓	✓	✓	15/15	3	✓	✓

<sup>a</sup> Requires Expansion Module 088U1100

<sup>b</sup> Requires App module 088U1101. Enables remote access, scheduling, set-back and more

<sup>c</sup> Requires Expansion Module 088U1100, surface temperature sensor 087B1165 and thermal actuator 193B2148 + 193B2005 fitted on the mixing shunt

<sup>d</sup> Via room thermostat

<sup>e</sup> Requires Radio Module 088U1103

Main accessories	Code no.	230V systems	24V systems	Wireless systems	Description
Floor Sensor for 24 V and 230 V	088U1110	✓	✓		For setting min., max. or fixed floor temperature.
App Module	088U1101		✓	✓	To enable smart phone / app access
Expansion Module	088U1100		✓	✓	To enable global away input, manual cooling input, dew point sensor, automatic cooling change-over and supply temperature control
Repeater	088U1102			✓	To extend wireless signal range
Radio Module	088U1103		✓	✓	To transform 24 V system into wireless system or as spare part for wireless system
Dew point sensor	088U0251		✓	✓	To prevent condensation in cooling application. Mounted on manifold. Powered by Expansion Module 088U1100
Surface temperature sensor, ESM-11	087B1165		✓	✓	For automatic change over between cooling and heating and for controlling supply temperature
Actuator ABN-F24NC	193B2148 + 193B2005		✓	✓	For "upside down" installation on mixing shunt in demand based supply temperature applications (requires high IP class). Remember adapter 193B2005 for RA connection
Thermal actuators for 24 V	088H3110 (NC) + 088H3111 (NO)		✓	✓	RA manifold connection. NO = Normally Open. NC = Normally Closed
Thermal actuators for 230 V	088H3112 (NC) + 088H3113 (NO)	✓			RA manifold connection. NO = Normally Open. NC = Normally Closed
Thermal actuators for 24 V	088H3140 (NC) + 088H3141 (NO)		✓	✓	M30 manifold connection. NO = Normally Open. NC = Normally Closed
Thermal actuators for 230 V	088H3142 (NC) + 088H3143 (NO)	✓			M30 manifold connection. NO = Normally Open. NC = Normally Closed





Danfoss Link™ Hydronic Controller  
 • 5 channels: 014G0103  
 • 10 channels: 014G0100



Danfoss Icon™ Wireless display / infrared thermostats  
 088U1081 / 088U1082



CF-RU Repeater unit  
 088U0230



Danfoss Link™ Central Controller



- with NSU: 014G0287 / 014G0289



- with PSU: 014G0286 / 014G0288



TWA-A, NC 24 V Thermal Actuator  
 088H3110



CF-EA External Antenna  
 088U0250



Radiator thermostat, Danfoss Link™  
 014G0001 / 014G0002



Danfoss Link™ Floor Thermostat  
 088L1905

Master controllers	Code no.	Features				
		Pump relay	Input relay for external signal	Boiler relay	Adaptive learning	Week schedule (via Danfoss Link™ Central Controller)
Danfoss Link™ Hydronic Controller, 5 channels	014G0103	✓	✓	✓	✓	✓
Danfoss Link™ Hydronic Controller, 10 channels	014G0100	✓	✓	✓	✓	✓

**Note:** All products require Danfoss Link™ Central Controller

Room thermostats	Code no.	Fits into switch frames	Touch user interface	On-wall	In-wall	Noiseless switching	Cooling enabled	Floor sensor enabled	Scheduling	Support multiple heat emitter types	Support dual heat emitters in same room	Away input	Thermal feedback	PWM	Max actuators	Temperature limitation	NC/NO option	Valve exercise	Adaptive learning	Temperature set-back button
Display, On-wall	088U1081		✓	✓		✓	✓ <sup>a</sup>		✓ <sup>d</sup>	✓ <sup>a</sup>	✓ <sup>a</sup>	✓ <sup>a</sup>		✓ <sup>a</sup>	2	✓	✓ <sup>a</sup>	✓ <sup>a</sup>	✓ <sup>d</sup>	✓ <sup>d</sup>
Infrared, On-wall	088U1082		✓	✓		✓	✓ <sup>a</sup>	✓ <sup>c</sup>	✓ <sup>d</sup>	✓ <sup>a</sup>	✓ <sup>a</sup>	✓ <sup>a</sup>		✓ <sup>a</sup>	2	✓	✓ <sup>a</sup>	✓ <sup>a</sup>	✓ <sup>d</sup>	✓ <sup>d</sup>

<sup>a</sup> Via master controller  
<sup>b</sup> Only 2-pipe systems.

<sup>c</sup> With build-in infrared sensor  
<sup>d</sup> Requires mobile application.

Accessories	Code no.	Description
Danfoss Link™ Central Controller	014G0287 / 014G0289	Controller with user friendly screen. With NSU (wall mounted). Required.
Danfoss Link™ Central Controller	014G0286 / 014G0288	Controller with user friendly screen. With PSU (flush-mounted). Required.
Repeater Unit, CF-RU	088U0230	To extend wireless signal range.
External Antenna, CF-EA	088U0250	To extend wireless signal range. Incl. 2 meter cable.
Cable for CF-EA	088U0255	Extension cable, 5 meters.
Thermal Actuator, TWA-A, NC 24 V	088H3110	RA manifold connection. Connect wire to hydronic controller.
Thermal Actuator, TWA-A, NO 24 V	088H3111	RA manifold connection. Connect wire to hydronic controller.
Thermal Actuator, TWA-K, NC 24 V	088H3140	M30×1.5 manifold connection. Connect wire to hydronic controller.
Thermal Actuator, TWA-K, NO 24 V	088H3141	M30×1.5 manifold connection. Connect wire to hydronic controller.

Other products...	...that can be controlled by Danfoss Link™ Central Controller	
Danfoss Link™ Floor Thermostat	088L1905	For on/off temperature control of electric heating. Can be connected with floor sensor (included) or Danfoss Link™ Room Sensor.
Radiator thermostat, living connect®	014G0001	With RA adapter.
Radiator thermostat, living connect®	014G0002	With RA + K (M30x1.5) adapter.





WT-T Room thermostat 088U0620  
 WT-D/DR Room thermostat 088U0622 / 088U0624  
 WT-P/PR Room thermostat 088U0625 / 088U0626



FH-WT Room thermostat 088H0022  
 FH-WP Room thermostat 088H0023  
 FH-WS Room thermostat 088H0024

Master Controller:  
 FH-WC 24 V – 10 outputs  
 088H0017



Thermal Actuator  
 088H3110 - 088H3113  
 088H3140 - 088H3143



FH-WF  
 Floor sensor  
 088H0025

Wired	Code no.	Fits into switch frames	Capacitive touch	On-wall	In-wall	Noiseless switching	Cooling input	Floor sensor enabled	Scheduling	Actuator on radiator <sup>1)</sup>	Away input	Thermal feedback	PWM	Max. actuators	Temperature limitation	NC/NO <sup>2)</sup>	Valve exercise	Adaptive learning	Temperature set-back button
<b>230 V BasicPlus<sup>2</sup></b>																			
BasicPlus <sup>2</sup> dial (WT-T)	088U0620			✓										10+					
BasicPlus <sup>2</sup> display (WT-D)	088U0622				✓			✓						10+	✓				✓
BasicPlus <sup>2</sup> display w/ relay (WT-DR) <sup>3)</sup>	088U0624				✓			✓						10+	✓				✓
BasicPlus <sup>2</sup> programmable (WT-P)	088U0625				✓			✓	✓					10+	✓				✓
BasicPlus <sup>2</sup> programmable w/ relay (WT-PR) <sup>3)</sup>	088U0626				✓			✓	✓					10+	✓				✓
<b>24 V FH-Wx</b>																			
FH-WT dial	088H0022			✓		✓								2		NC			
FH-WP dial (tamperproof)	088H0023			✓		✓								2	✓ <sup>4)</sup>	NC			
FH-WS dial (featured)	088H0024			✓		✓		✓				✓		2		NC			✓

<sup>1)</sup> Algorithms optimized for controlling actuator on radiator.  
<sup>2)</sup> If a Normally Open (NO) actuator is connected, the pump or boiler relay cannot be used as the relay function is inverted.  
<sup>3)</sup> With auxiliary switch. Requires an inner socket box size of min. 46.2 x 62.3 mm (W x H).  
<sup>4)</sup> Tamperproof.

Connection Boxes	Code no.	Features				Description
		Pump relay	Cooling	Standby relay	Boiler relay	
Master Controller, FH-WC 24 V – 10 outputs	088H0017	✓			✓	Required for all 24 V room controls.

\* Note! If a Normally Open (NO) actuator is connected, the pump or boiler relay cannot be used as the relay function is inverted.

Accessories – for hardwired solutions	Code no.	For system		Features
		230 V	24 V	
Thermal actuators for 24 V	088H3110 (NC) + 088H3111 (NO)		✓	RA manifold connection. Connected via connection box 088H0017.
Thermal actuators for 230 V	088H3112 (NC) + 088H3113 (NO)	✓		RA manifold connection. Connected directly with 230 V room thermostats or conn. box 088H0016.
Thermal actuators for 24 V	088H3140 (NC) + 088H3141 (NO)		✓	M30 manifold connection. Connected via connection box 088H0017.
Thermal actuators for 230 V	088H3142 (NC) + 088H3143 (NO)	✓		M30 manifold connection. Connected directly with 230 V room thermostats or conn. box 088H0016.
Floor sensor, for FH-Wx – 24 V	088H0025		✓	For setting either minimum or maximum floor temperature.
Floor sensor, for FH-CWx and WT-x	088U0610	✓		For setting min., max. or fixed floor temperature.
Danfoss <i>Icon</i> ™ floor sensor	088U1110	✓		For setting min., max. or fixed floor temperature.



# MANIFOLDS, MIXING SHUNTS AND CABINETS



## MEET THE FAMILY MANIFOLDS AND MIXING SHUNTS

Combine a **mixing shunt** → ... with the **ball valves** → ... then the **manifolds** → and then an **air vent type**

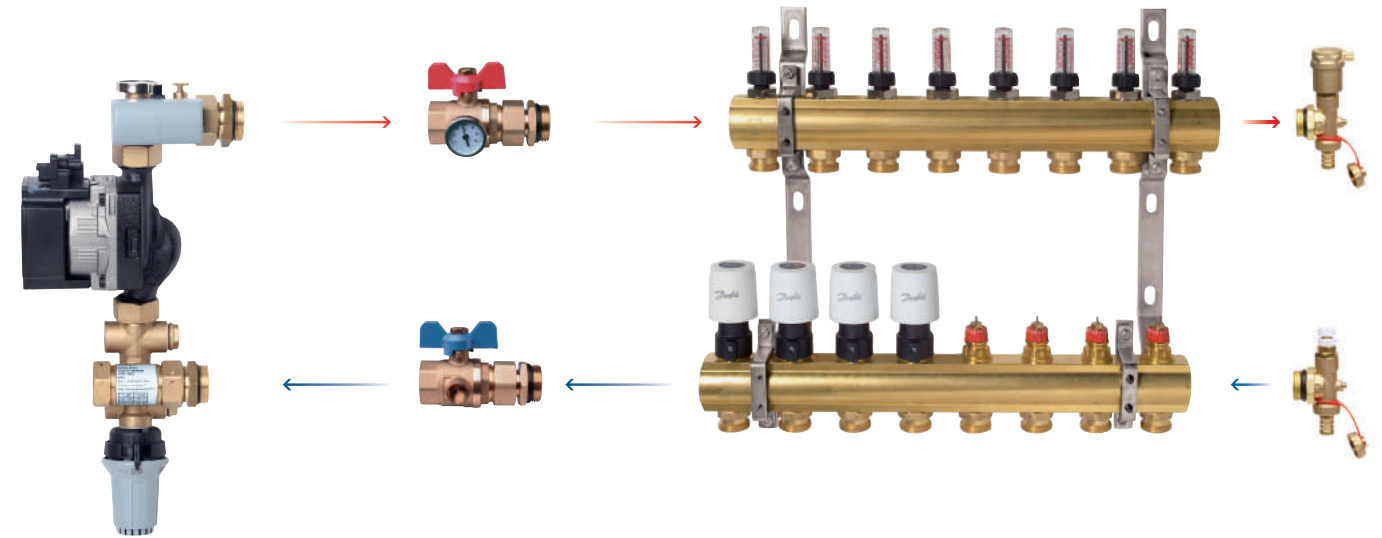

### FHF

With pre-setting but without flow meter. FHF with flow meter (FHF-F) is shown on the above picture.

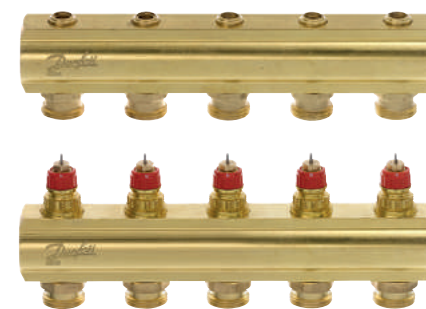

### FH-ME (BasicPlus)

No flow meter and no pre-setting.



### SSM-F

With pre-setting and flow meter.



### SSM

With pre-setting and without flow meter.

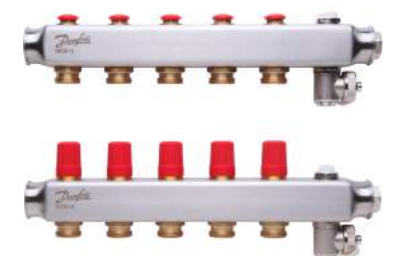

### Mixing shunt

Mounting the mixing shunt is extremely easy, as it is very compact from only 110 mm in installation dimension. The mixing shunt is mounted directly on the manifold on either the left or right-hand side, it can also be angle mounted with angle fittings as accessories.

#### Product highlights:

- » Prefabricated for quick and easy mounting
- » Very compact - fits into cabinets



# TESTED TO LAST FOR DECADES

**We have minimized failure rates  
so you can maximize your business.**

During production and development, all components are subjected to various tests to maximize their efficiency and working life.

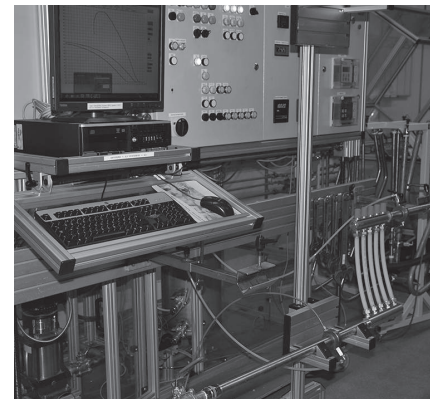
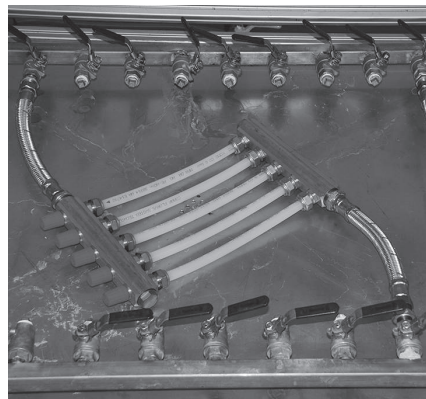
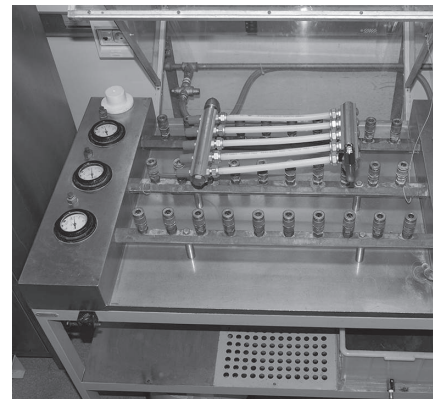

## Pressure test

In a pressure test, the manifolds, fittings and pipes are assembled and placed under pressure. In this way, the manifold, fittings and pipes can be tested to withstand even unrealistic pressures.

## Temperature test

In a temperature test, the floor heating system is exposed to different heat levels. These variations make the components expand and contract, allowing us to test the sustainability of the different components.

## Capacity test

In a capacity test, the flow through the valves is tested, enabling us to find the kvs-value. This allows us to calculate how much energy each circuit can provide to the room.

## High quality **brass**

The purity and quality of the brass used in Danfoss manifolds minimizes the risk of corrosion and leakages.

FHF and FHF-F manifolds are all produced according to the CW617N standard, which ensures a very high brass quality.

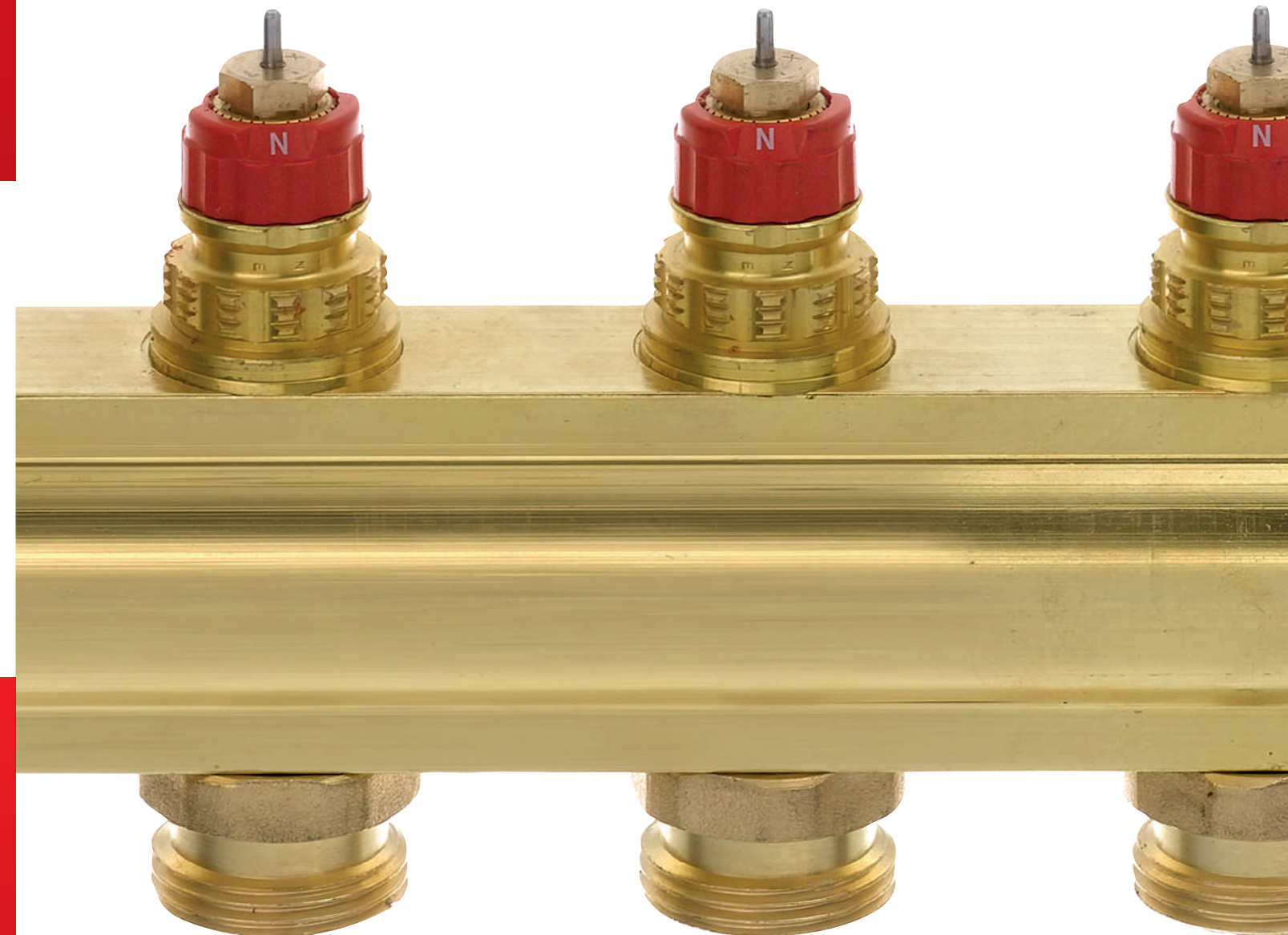

# Manifolds with pre-setting Reduce call-backs and provide comfort and savings for your customers

A study with 537 plumbers from seven countries shows that installers are called back to approx. 20% of installations. The saving potential for leaving behind a well-functioning system is enormous.

**TIP!** Make sure to explain the importance of perfect hydronic balancing to your customers.

# More than just pre-setting We give you the best solutions on the market

A Danfoss manifold with pre-setting offers better distribution of water and energy, which ensures the right temperatures in different rooms.

## Typical installation **with** pre-setting

With hydronic balancing, the right amount of water will be distributed to the right rooms. Hydronic balancing can be achieved via manifold pre-setting or by using the automatic balancing feature available with some Danfoss Icon™ room controls.

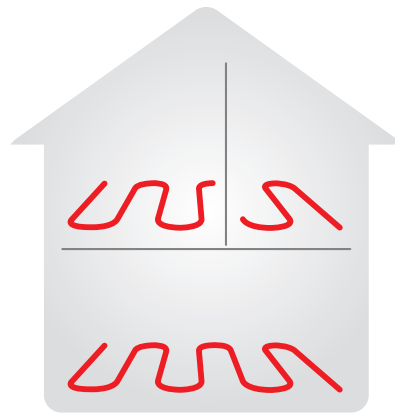

## Typical installation **without** pre-setting

Without hydronic balancing valves, you risk the scenario of very uneven heat distribution which decreases comfort.

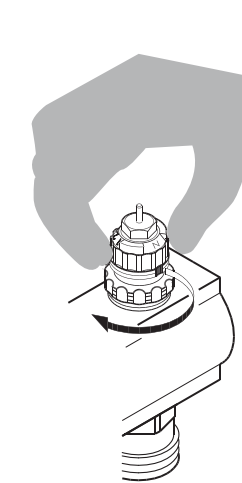
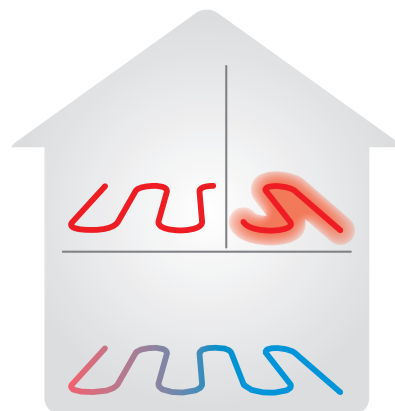

Danfoss **throttle** pre-setting

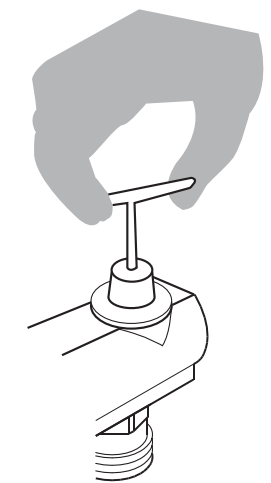

**Typical** non-Danfoss pre-setting

## Comparison

- |   |  |
|---|--|
| <ul style="list-style-type: none"> <li>• No tools required. Can be done quickly and easily</li> <li>• Precise pre-setting scale visible on valve</li> <li>• Easy to use pre-setting guide</li> <li>• Pre-setting can be checked after installation (visible setting)</li> <li>• Spindle and valve seat produced as 1 piece – provides extreme accuracy</li> </ul> | <ul style="list-style-type: none"> <li>• Tools required. Time consuming</li> <li>• Normally not visible on valve</li> <li>• More complex pre-setting</li> <li>• Pre-setting cannot be checked without a visible scale</li> <li>• Spindle uses manifold as seat. Difficult to set accurately</li> </ul> |
|---|--|



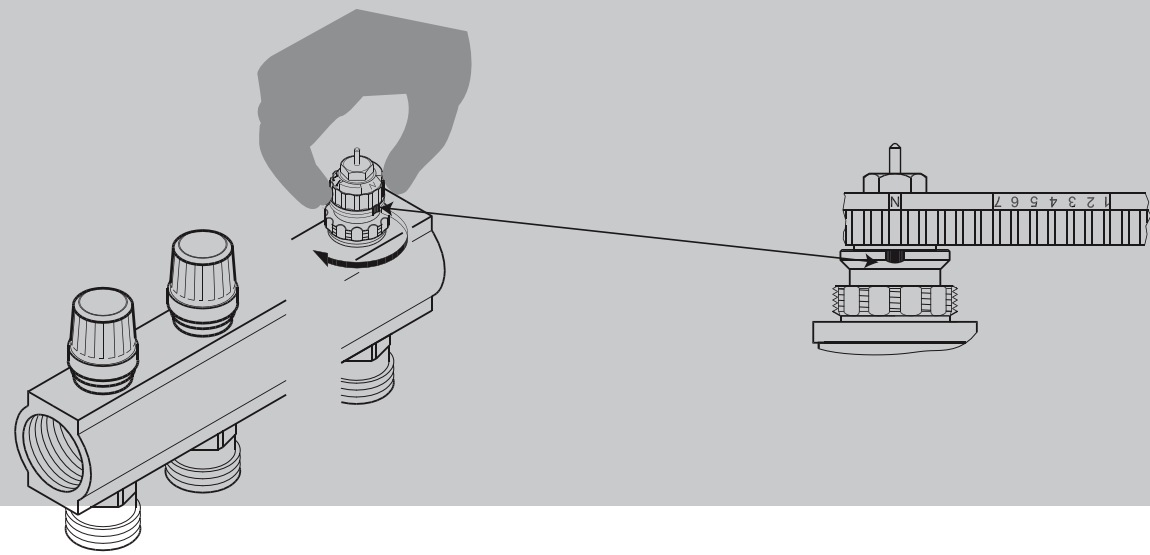

## Accurate pre-setting example

### How to pre-set the valves on a Danfoss manifold:

Step 1: Identify the column that describes the longest pipe in the system (in the below example 100 meters)

Step 2: Identify the row that describes the second longest pipe in the system (in the below example 85 meters)

Step 3: The column and row intersect in a cell with a value (in the below example the value "5,5"). This is the pre-setting value of the valve connected to the pipe in question

Step 4: Repeat step 2 and 3 for the next pipes

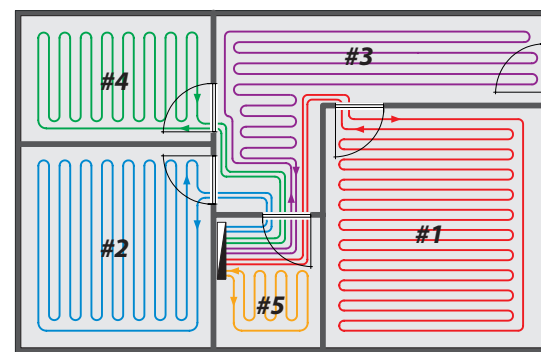

20 x 2 mm

	120	115	110	105	100	95	90	85	80	75	70	65	60	55	50
120	n														
115	7	n													
110	6	6,5	n												
105	5,5	6	7	n											
100	5	5,5	6	7	n										
95	4,5	5	5,5	6,5	7	n									
90	4	4,5	5	5,5	6	7	n								
85	4	4	4,5	5	5,5	6	7	n							
80	3,5	4	4	4,5	5	5,5	6	7	n						
75	3,5	3,5	4	4	4,5	5	5,5	6	7	n					
70	3	3,5	3,5	4	4,5	4,5	5	5,5	6	7	n				
65	3	3	3,5	3,5	4	4	4,5	5	5	6	7	n			
60	3	3	3	3,5	3,5	4	4	4,5	4,5	5	6	7	n		
55	2,5	3	3	3	3,5	3,5	4	4	4,5	5	6	6,5	n		
50	2,5	2,5	2,5	3	3	3	3,5	3,5	4	4	4,5	5	5,5	6,5	n
45	2	2,5	2,5	2,5	3	3	3	3	3,5	3,5	4	4,5	4,5	5	6
40	2	2	2	2,5	2,5	3	3	3	3,5	3,5	4	4	4,5	5	
35	1,5	1,5	1,5	2	2	2,5	2,5	2,5	2,5	3	3	3,5	3,5	4	4,5
30	1	1	1	1,5	1,5	2	2	2	2,5	2,5	2,5	3	3	3,5	4
25	1	1	1	1	1,5	1,5	1,5	2	2	2,5	2,5	2,5	3	3,5	
20	1	1	1	1	1	1	1	1	1,5	1,5	2	2	2,5	2,5	
15	1	1	1	1	1	1	1	1	1	1	1	1	1,5	1,5	2
10	1	1	1	1	1	1	1	1	1	1	1	1	1	1	1

#1 100 m

#1 100 m

#2 85 m

#3 70 m

#4 60 m

#5 40 m

⋮

# MIXING & MIDI SHUNTS WHAT TO CONSIDER

1.

## TEMPERATURE

IS THERE A HIGH TEMPERATURE HEAT SOURCE?  
(e.g. boiler or district energy)

**YES**

**NO**

NO NEED FOR MIXING SHUNT

2.

## VARIABLE SPEED

USE A MIXING SHUNT  
Should it be with a variable speed pump  
for extra energy saving?

**YES**

**NO**

CHOOSE  
VARIABLE SPEED

CHOOSE  
FIXED SPEED



FHM-C1  
» 15-70



FHM-C2  
» 15-70



MIDI-SHUNT  
Solution with 1 circuit,  
up to 20 m<sup>2</sup>



FHM-C5  
» 15-40

FHM-C6  
» 15-60

# MANIFOLDS WHAT TO CONSIDER

1.

## BALANCED SYSTEM

Is balancing via pre-setting or flow meters required?

**YES**

**NO**  
CHOOSE FH-ME (BASICPLUS) OR FHF-B

2.

## FLOW METER

Are flow meters required?

**YES**

**NO**  
CHOOSE FHF WITH PRE-SETTING

3.

## CHOOSE

FHF-F OR SSM-F WITH BOTH PRE-SETTING AND FLOW METER

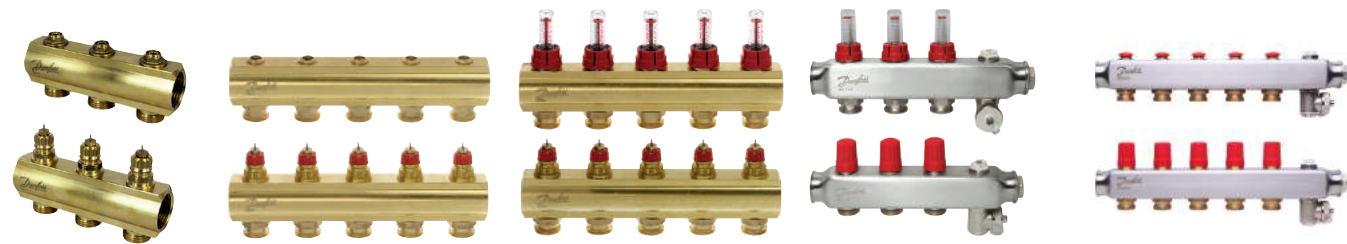

**FH-ME (BasicPlus)**  
No flow meter and no pre-setting

**FHF**  
With pre-setting

**FHF-F**  
With pre-setting and flow meter

**SSM-F**  
With pre-setting and flow meter  
Premounted components

**SSM**  
With pre-setting and without flow meter.



**End caps**  
088U0582



**Connection piece**  
088U0583



**End section**  
088U0786



**End section**  
088U0785



**Ball valves**  
088U0822



**Reduction bushes**  
088U0584



**Mounting brackets**  
088U0585

**In-wall cabinet**  
088X0900

**On-wall cabinet**  
088X0905

# MANIFOLD OVERVIEW

Manifolds	Code no.	Number of outputs	Flow meter	Pre-setting	Control valves for actuators	Solution	Material	Working Pressure
FHF-F	088U0522-32	From 2+2 (088U0522) – To 12+12 (088U0532)	✓	✓	✓ (TWA-A)	Only manifold <sup>1)</sup>	Brass	6 bar
FHF	088U0502-12	From 2+2 (088U0502) – To 12+12 (088U0512)		✓	✓ (TWA-A)	Only manifold <sup>1)</sup>	Brass	10 bar
FH-ME (BasicPlus)	088U0612-18	From 2+2 (088U0612) – To 8+8 (088U0618)			✓ (TWA-A)	Only manifold <sup>1)</sup>	Brass	10 bar
FHF-B with shut-off	088U0542-52	From 2+2 (088U0542) – To 12+12 (088U0552)				Only manifold <sup>1)</sup>	Brass	10 bar
SSM-F	088U0752-62	From 2+2 (088U0752) – To 12+12 (088U0762)	✓	✓	✓ (TWA-A)	Assembled <sup>2)</sup>	Stainless steel	6 bar
SSM	088U0802-12	From 2+2 (088U0802) – To 12+12 (088U0812)		✓	✓ (TWA-A)	Assembled <sup>2)</sup>	Stainless steel	10 bar

<sup>1)</sup> You will need to order end-piece (1 pcs. 088U0582 or 2 pcs. end section 088U0786 or 088U0785), mounting brackets (088U0585) and ball valves (088U0822).

<sup>2)</sup> You will only need to order mounting brackets (088U0585).

Accessories	Code no.	Description
End caps (2 pieces)	088U0582	Used where air vents are not used.
End section – automatic air vent	088U0785	Includes automatic air vent and drain valve.
End section – manual air vent	088U0786	Includes manual air vent and drain valve.
Mounting brackets (2 pieces)	088U0585	Used to mount manifold.
Reduction bushes	088U0584	Enables connection between 3/4" pipe and 1" manifold.
Connection piece	088U0583	For combining two or more manifolds.
Ball valves (2 pieces)	088U0822	To shut off water to entire manifold.

Cabinets	Code no.	On-wall	In-wall	Width <sup>1)</sup> [mm]	Depth <sup>2)</sup> [mm]	Height [mm]	Max. FHF/ FHF-F outputs A <sup>3)</sup>	Max. FHF/ FHF-F outputs B <sup>4)</sup>	Max. FHF/ FHF-F outputs C <sup>5)</sup>	Max. FHF/ FHF-F outputs D <sup>6)</sup>
FHF-FCA	088X0900		✓	395	110-170	650	4	2	0	0
FHF-FCB	088X0901		✓	595	110-170	650	8	6	5	3
FHF-FCC	088X0902		✓	795	110-170	650	13	10	9	7
FHF-FCD	088X0903		✓	995	110-170	650	16	12	12	11
FHF-FCE	088X0904*		✓	1195	110-170	650	18	14	13	12
FH-SCA	088X0905	✓		450	119	650	4	2	0	0
FH-SCB	088X0906	✓		700	119	650	8	6	5	3
FH-SCC	088X0907	✓		850	119	650	13	10	9	7
FH-SCD	088X0908	✓		1000	119	650	16	12	12	11
FH-SCE	088X0909*	✓		1300	119	650	18	14	13	12

<sup>1)</sup> In-wall mounted cabinets need a build-in hole, which is about 5 mm larger than the width mentioned in the table and 650 mm above floor surface.

\* Minimum order quantity: 11 pcs.  
Minimum delivery time: 6 weeks.

<sup>2)</sup> The cabinets are adjustable in depth from 110 mm to 170 mm.

<sup>3)</sup> Manifold + airvent

<sup>4)</sup> Manifold + airvent + ball valve

<sup>5)</sup> Manifold + airvent + ball valve + mixing shunt

<sup>6)</sup> Manifold + airvent + mixing shunt



# MIXING SHUNT OVERVIEW

# MIDI SHUNT OVERVIEW

Mixing shunt	Code no.	Features			
		Pump type	Pump speed	Additional accessories included	Pump energy class
FHM-C1	088U0094	UPM3 Auto L 15-70	Variable	-	A
FHM-C2 (without FH-TC)	088U0092	UPM3 Auto L 15-70	Variable	-	A
FHM-C5	088U0093	UPS 15-40	Fixed, non-adaptive	-	C
FHM-C6	088U0096	UPS 15-60	Fixed, non-adaptive	-	C

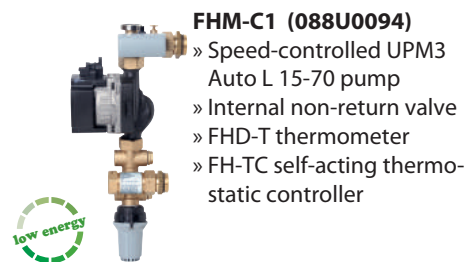

**FHM-C1 (088U0094)**  
 » Speed-controlled UPM3 Auto L 15-70 pump  
 » Internal non-return valve  
 » FHD-T thermometer  
 » FH-TC self-acting thermostatic controller

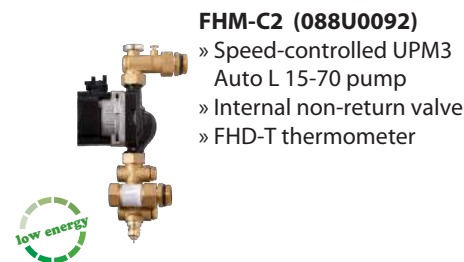

**FHM-C2 (088U0092)**  
 » Speed-controlled UPM3 Auto L 15-70 pump  
 » Internal non-return valve  
 » FHD-T thermometer

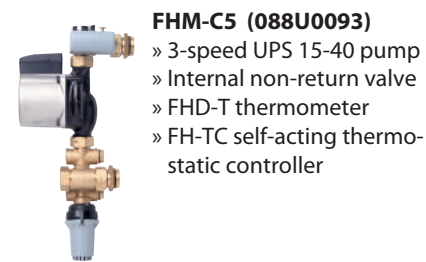

**FHM-C5 (088U0093)**  
 » 3-speed UPS 15-40 pump  
 » Internal non-return valve  
 » FHD-T thermometer  
 » FH-TC self-acting thermostatic controller

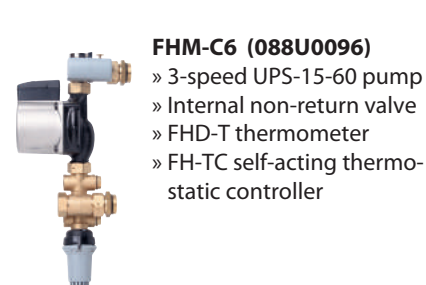

**FHM-C6 (088U0096)**  
 » 3-speed UPS-15-60 pump  
 » Internal non-return valve  
 » FHD-T thermometer  
 » FH-TC self-acting thermostatic controller

Accessories for mixing shunt	Code no.	Description
Safety thermostat	088U0301	Stops pump if supply temperature is above 55° C
Measurement set	088U0304	Output for measuring flow
Angle fittings	088U0305	For mounting mixing shunt at a different angle
Insulation capsule for UPM3 pump	088U0075	Insulation capsule for UPM3 pump



**Safety thermostat (088U0301)**



**Measurement set (088U0304)**



**Angle fittings (088U0305)**



**Insulation capsule for UPM3 pump (088U0075)**

Midi shunt – for small floor heating systems	Code no.	Measurement mm (H x W x D)	Pre-mounted components			
			Pump type	Controls	System size	Actuators
Midishunt with 1 circuit	088U0851	420 x 290 x 100	UPM3 Auto L 15-70	088U1005	Up to 20 m <sup>2</sup>	✓

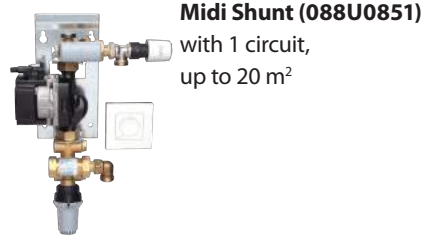

**Midi Shunt (088U0851)**  
 with 1 circuit,  
 up to 20 m<sup>2</sup>

# FLOOR HEATING PANELS

## FLOOR HEATING PANELS MEET THE FAMILY

### Basic™ screed systems

Using tools and laying pipes at the same time is difficult. No tools are required for BasicRail™ and BasicGrip™. This means that one person can lay the pipes alone when using BasicRail™ and BasicGrip™.

For BasicRail™ the rails need to be installed first. The BasicGrip™ panel, on the other hand, contains both insulation and knobs that hold the pipes in place. That means fewer work processes with BasicGrip™.

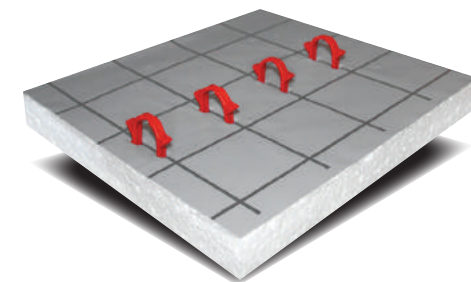

BasicClip™

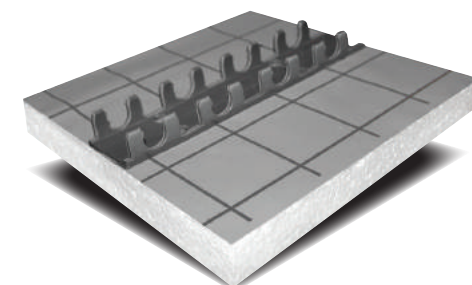

BasicRail™



BasicGrip™

### Panels What to consider

1.

#### INSTALLATION

Is 1-person installation important?

**YES**

**NO**

CHOOSE  
**BasicClip™**

2.

#### WORK PROCES

Is few work processes important?

**YES**

**NO**

CHOOSE  
**BasicRail™**

CHOOSE  
**BasicGrip™**



# FLOOR HEATING PANEL OVERVIEW



BasicGrip™ BasicClip™ BasicRail™



Clips for BasicRail™ 088X0043  
Clips for foil 088X0060



Connection panel 088X0053



Manifold/multi-panel 088X0054

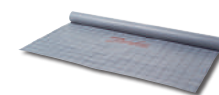

Foil 088X0130

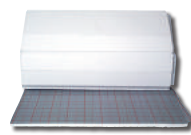

Insulation roll 088x0072



BasicClip™ Tool 088X0061



Conduit elbow 088X0058



Perimeter insulation 088X0065



Basic movement gap strip 088X0066



Basic pipe sleeve 088X0067

System overview	Installation time (min./m <sup>2</sup> at c/c 300 mm)	Available insulation thickness (mm)	Installation tools needed
BasicGrip™	7,5	0, 11, 35	None
BasicClip™	8	0, 20, 35 (panels) / 30 (10 m <sup>2</sup> rolls)	BasicClip Tool
BasicRail™	6,5	0, 20, 35	None

BasicRail™	Code no.	Consumption (m/m <sup>2</sup> )
FH-BRA – Rails, 2 meters for 16x2 pipe	088X0040	1,2
FH-BRC – Rails, 3 meter, for 20x2,25 pipe	088X0042	1,2
FH-BRD – Clips for BasicRail™, 500 pcs	088X0043	

BasicClip™	Code no.	Consumption, pcs./m <sup>2</sup> with c/c 300 mm	Consumption, pcs./m <sup>2</sup> with c/c 250 mm	Consumption, pcs./m <sup>2</sup> with c/c 200 mm	Consumption, pcs./m <sup>2</sup> with c/c 150 mm	Consumption, pcs./m <sup>2</sup> with c/c 100 mm
FH-BCB – Clips for BasicClip™, 300 pcs	088X0062	7	8	10	13	20
FH-BCC – Clips for foil, 200 pcs.	088X0060					

BasicGrip™ panels and rolls	Code no.	Form	Insulation thickness (mm)	Size (m <sup>2</sup> )
FH-BGA – Standard panel	088X0050	Panel	35	1
FH-BGB – Standard panel	088X0051	Panel	11	1
FH-BGC – Standard panel	088X0052	Panel	0	1
FH-BGD – Connection panel	088X0053	Panel	0	0,1
Manifold/multi-panel	088X0054	Panel	35	0,5
Manifold/multi-panel	088X0055	Panel	11	0,5
Manifold/multi-panel	088X0056	Panel	0	0,5
Basic Panel Standard	088X1051	Panel	18	0,62
Basic Panel Ultra	088X1052	Panel	18	0,62

BasicClip™ and BasicRail™ rolls	Code no.	Form	Insulation thickness (mm)	Size (m <sup>2</sup> )	System	
					BasicClip™	BasicRail™
Basic insulation roll	088X0072	Roll	30	10	✓	
Basic insulation roll	088X0073	Roll	20		✓	

Other accessories	Code no.	For which system			Comments
		BasicGrip™	BasicClip™	BasicRail™	
FH-BGI – Conduit elbow	088X0058	✓			For 16-20 mm pipe.
FH-BK – Perimeter insulation	088X0065	✓	✓	✓	
FH-ACA – Basic movement gap strip	088X0066	✓	✓	✓	2 meters.
FH-ACB – Basic pipe sleeve	088X0067	✓	✓	✓	For 16 mm pipe and pipe length 40 cm.

# QUALITY PIPES

## Pipes What to consider

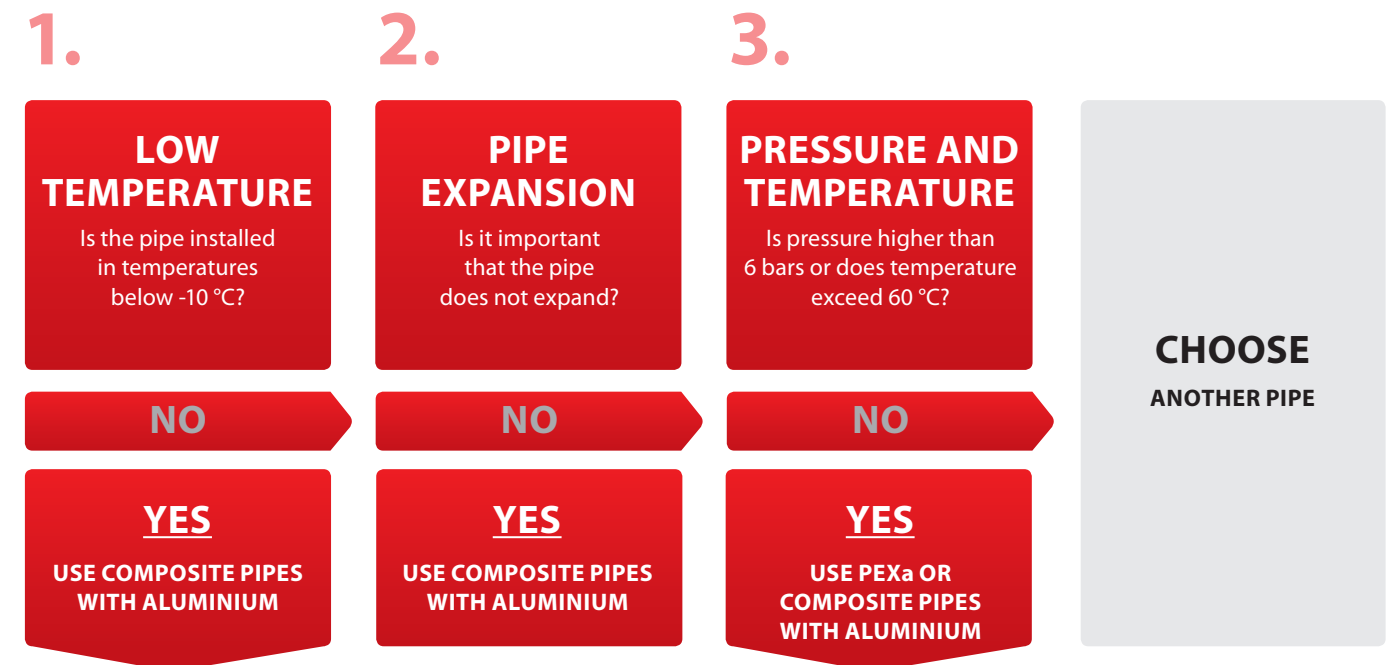

**COMPOSITE PIPE WITH ALUMINIUM**

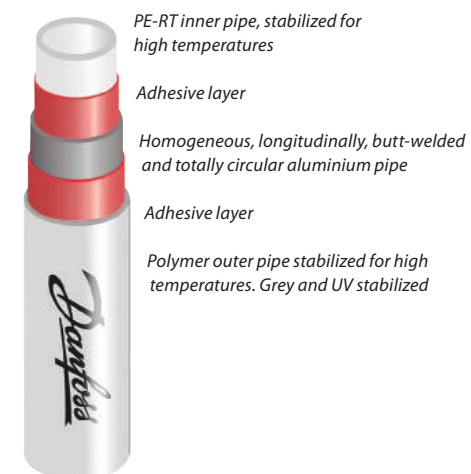

### FIVE LAYERS OF QUALITY

No matter which Danfoss pipe you choose it always has five layers. Having the oxygen barrier protected by a pipe wall and adhesive layer will ensure that minimal oxygen will be able to enter your installation and help ensure that the installation will remain corrosion free over time.

**PEXa PIPE**



### CROSS LINKED FOR MAXIMUM OUTPUT

Our PEXa pipes are produced according to the ISO 15875 standard and has a cross linking degree of min. 70 %. The heat transfer coefficient of the pipe is 0,41 W/m K which will ensure that energy is transferred in the fastest possible way from water to the floor.



# TESTING OUR PIPES TO THE MAX

## All pipes are thoroughly tested to meet the highest quality standards.

Danfoss pipes are subjected to a range of different tests to ensure optimum product quality and working life. During production, the pipes undergo real life simulation tests and quality inspections to meet our precise tolerances.

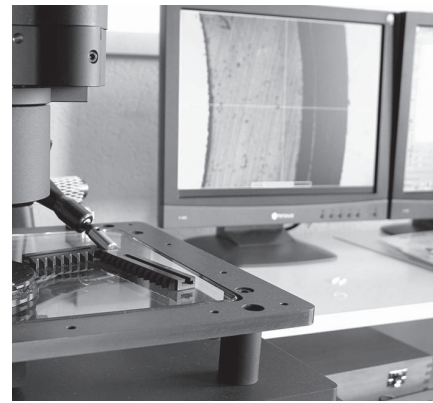

### Layer and wall thickness

The thickness of each layer is measured. Thickness needs to be kept within narrow tolerances to ensure that the fittings precisely match the pipes, enabling them to withstand high pressures.

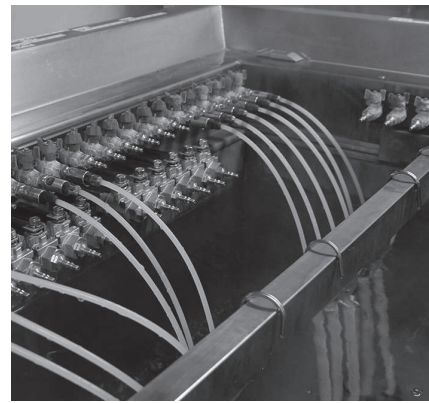

### Long-term pressure test

The pipes undergo a thermal cycle test. The test simulates the conditions that pipes are exposed to during their lifetime. The test is based on the ISO 22391 standard.

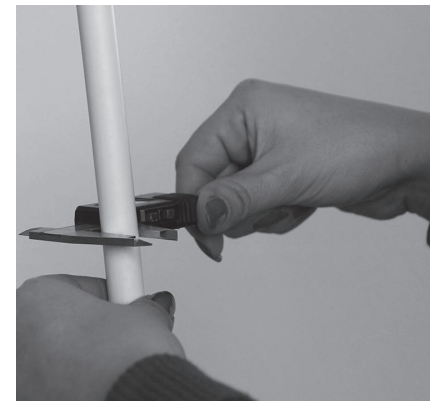

### Outer diameter test

During production, random tests are carried out on the outer diameter of our pipes to ensure that tolerances are met.

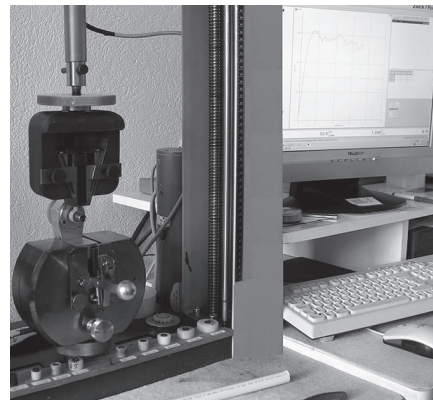

### Adhesion test

The pipes consist of several layers that are "glued" together. In the lab, their durability is thoroughly tested to prevent the layers from dissolving over time.

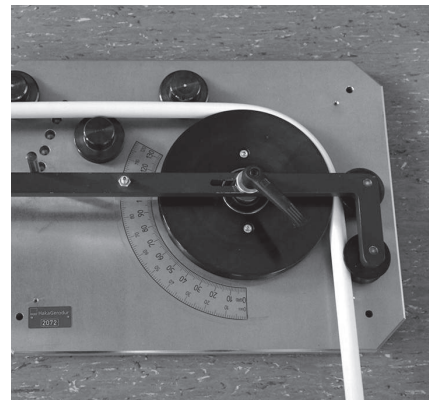

### Bending relaxation test

The extent to which the pipe changes shape when bent is important for the resistance in the pipe. An oval pipe will increase resistance, which may affect pump requirements.

# PIPE OVERVIEW



FH composite pipe  
088X0001



FH PEXa pipes  
088X0950

Most popular pipes	Code no.	Dimension	Material type	Coil length	Oxygen barrier	Max. temperature	Max. pressure	Life expectancy
Composite pipe	088X0001	16 x 2,0 mm	PE-RT/Alu/PE-HD	200 m	alu	95 °C	10 bar	50 years
Composite pipe	088X0003	16 x 2,0 mm	PE-RT/Alu/PE-HD	500 m	alu	95 °C	10 bar	50 years
PEXa pipe	088X0950	14 x 2,0 mm	PEXa	240 m	EVOH	95 °C	6 Bar	50 years
PEXa pipe	088X0951	16 x 2,0 mm	PEXa	120 m	EVOH	95 °C	6 Bar	50 years
PEXa pipe	088X0952	16 x 2,0 mm	PEXa	240 m	EVOH	95 °C	6 Bar	50 years
PEXa pipe	088X0968	16 x 2,0 mm	PEXa	350 m	EVOH	95 °C	6 Bar	50 years
PEXa pipe	088X0969	16 x 2,0 mm	PEXa	400 m	EVOH	95 °C	6 Bar	50 years
PEXa pipe	088X0953	16 x 2,0 mm	PEXa	600 m	EVOH	95 °C	6 Bar	50 years
PEXa pipe, reinforced	088X0954	16 x 2,2 mm	PEXa	240 m	EVOH	95 °C	10 bar	50 years
PEXa pipe	088X0957	18 x 2,0 mm	PEXa	240 m	EVOH	95 °C	6 bar	50 years
PEXa pipe	088X0958	18 x 2,0 mm	PEXa	600 m	EVOH	95 °C	6 bar	50 years
PEXa pipe	088X0959	20 x 2,0 mm	PEXa	120 m	EVOH	95 °C	6 Bar	50 years
PEXa pipe	088X0961	20 x 2,0 mm	PEXa	400 m	EVOH	95 °C	6 Bar	50 years
PEXa pipe	088X0963	25 x 2,3 mm	PEXa	200 m	EVOH	95 °C	6 Bar	50 years



Press fitting 16 x 2 mm  
088X0020



Press fitting 20 x 2,25 mm  
088X0021



Screw coupling 16 x 2 mm  
088X0025



Screw coupling 20 x 2,25 mm  
088X0026



Fitting G 3/4",  
internal thread

Accessories for pipes	Code no.	Composite pipe	PEXa pipe	Description
Fitting 14 x 2,0 mm	013G4154		X	Fitting for connecting pipes to manifolds or valves with 3/4" thread.
Fitting 16 x 2,0 mm	013G4156		X	Fitting for connecting pipes to manifolds or valves with 3/4" thread.
Fitting 16 x 2,0 mm	013G4186	X		Fitting for connecting pipes to manifolds or valves with 3/4" thread.
Fitting 16 x 2,2 mm	013G4163		X	Fitting for connecting pipes to manifolds or valves with 3/4" thread.
Fitting 18 x 2,0 mm	013G4158		X	Fitting for connecting pipes to manifolds or valves with 3/4" thread.
Fitting 20 x 2,0 mm	013G4160		X	Fitting for connecting pipes to manifolds or valves with 3/4" thread.
Fitting 20 x 2,25/3 mm	013G4093	X		Fitting for connecting pipes to manifolds or valves with 3/4" thread.
Press fitting 16 x 2,0 mm	088X0020	X		Connection fitting for joining two pipes e.g. for repairs (press tool required).
Press fitting 20 x 2,25 mm	088X0021	X		Connection fitting for joining two pipes e.g. for repairs (press tool required).
Screw coupling 16 x 2,0 mm	088X0025	X	X	Connection fitting for joining two pipes e.g. for repairs (fittings incl. insulator ring).
Screw coupling 20 x 2,25 mm	088X0026	X		Connection fitting for joining two pipes e.g. for repairs (fittings incl. insulator ring).



# CASE STORIES



## Energy makeover generates efficient and controllable heating

### Renovating a private house

A stone's throw from Frankfurt-am-Main, Germany, the house was built in 1984 and boasted what was then state-of-the-art insulation. When the current owners took over the house, in addition to inadequate roof insulation by today's standards, the underfloor heating was not sufficiently controllable and drove up energy consumption.

### Meeting the challenge

The existing underfloor heating system was slow to heat up, virtually unregulated and worked continuously at too high a flow rate. This meant excessive room temperatures and a high level of energy waste. In addition, the manifold's control valves were extremely calcified by old leaks and the actuators were completely disconnected and disabled.

### Comprehensive renovation

Looking for suitable products, the contractor identified the Danfoss CF2<sup>+</sup> system. This wireless solution offers individual room control and excellent regulation and management features. For the twin heating circuits, two CF-MC Master Controllers were installed along with an external CF-EA antenna to ensure good wireless contact. Once the old system had been fully overhauled, the valve flow settings were defined to ensure correct hydronic balance.

### Room-by-room heating control

A CF-RF thermostat with infrared floor sensor was fitted in the reception room to ensure an adequate base temperature. This device also regulates floor temperature when secondary heat sources are in use, such as a fireplace. Other rooms were equipped with CF-RD thermostats. A CF-RC remote control was fitted to look after timing and the old manifold was replaced for a FHF-F equipped with new TWA-A actuators.

### Increased comfort and energy savings

The biggest advantage over the old solution was the achievement of genuine heating comfort. Temperature can now be individually set and regulated in each room, which offers excellent cost savings in a household with children and working adults.

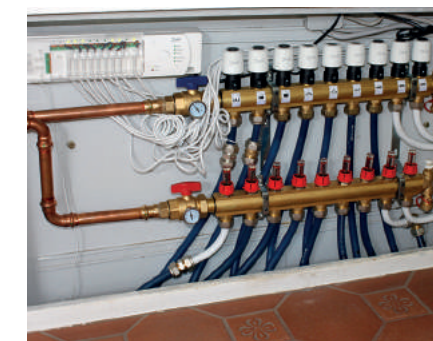

**Country:** Germany

**Building type:** 1-family house

**Renovation year:** 2013

**Size:** 220 m<sup>2</sup>

**Heat emitter:** Floor Heating

**Control type:**  
CF2<sup>+</sup>, FHF-F and TWA-A

**Heat source:** Gas, with water-based floor heating

**Company name:**  
Braun Haustechnik, Dreieich

**Company industry:**  
Plumbing

**Private consumer name:**  
Klaus Gerlach, Wehrheim



The wireless CF2<sup>+</sup> system removes the need for expensive cable laying and almost all the restoration work was carried out in the control cabinet. The work caused no mess and both installation and commissioning were very straightforward.

D. Braun,  
Braun Haustechnik







“With the Danfoss CF2 system we are able to control the underfloor heating and cooling, and can also ensure future flexibility for repositioning of the thermostats at the same time.”

Bas Linsen  
Underfloor heating constructor

## Underfloor heating and cooling For year round comfort

### A sustainable solution

In the Dutch city of Rotterdam, an office building from the 60's was completely stripped to its core and re-built. The project involved creating new offices and adding a further nine floors of luxury apartments on top. The developer wanted a highly sustainable climate system with both heating and comfort cooling. Heat is supplied to the building via the city's district heating system. To achieve the desired cooling effect, a customized solution was developed that involved drawing water from the river Maas, which flows right alongside the building. The water is then fed into heat exchangers to provide the cooling.

### Floor heating and cooling

To ensure that residents in the apartments could enjoy the most comfortable possible living experience, the decision was taken to use floor heating. During the warm months of the year, this system is also able to contribute to cooling the apartments. A manual switch to change from heating to cooling operation ensures that heating

and cooling cannot work simultaneously and avoids wasting energy.

### Flexibility required

Throughout the apartments, non-structural stud walls were used to give future owners the flexibility to arrange the room layout to suit their personal preferences. This design choice meant that the temperature controls in each of the rooms needed to be easy to relocate.

### Wireless controls

A Danfoss solution using the CF2 wireless control system was chosen to accommodate the demands of the innovative design concept. This allowed temperatures to be set individually in each room. In addition, the wireless CF-R thermostats provided the necessary flexibility for possible future changes to the room layout in the apartments. Thanks to 2-way communication between room thermostats and the central master controller on a frequency of 868.42 MHz, the wireless system is extremely reliable.



**The apartment cabinet**  
Heating and cooling supplies enter the apartment and are connected to the manifold. A manual switch allows the apartment occupants to determine between heating or cooling control. CF2 contains several features to optimize control in floor-cooling applications and the CF-MC Master Controller automatically opens or closes the electric actuators. Each is controlled by one of the CF-R room thermostats.

**Country:** The Netherlands  
**Building type:** Apartments  
**Building year:** 2012  
**Size:** 36 x 210 m<sup>2</sup>  
**Heat emitter:** Underfloor heating  
**Cool emitter:** Underfloor cooling  
**Control type:** CF2 (CF-MC, CF-RD, CF-RS, CF-EA)  
**Heat source:** District heating  
**Cooling source:** River water  
**Company name:** Jupiter Vloerverwarming Benelux BV  
**Company industry:** Underfloor heating construction  
**Private consumer name:** Mr. and Mrs. Schoneveld

## Well-balanced floor heating comfort in 17 high-rise apartment buildings

### Ensuring comfortable heating

The "Taiyang Gongyuan" project in Beijing, China, includes 17 residential buildings with a total of 2,154 apartments. All buildings are heated via district heating. Due to the large size of the buildings, each with up to 29 floors, establishing proper hydronic balancing was a priority. This would eliminate complaints from residents about uneven heating while providing the desired high level of indoor comfort. To meet both requirements, Danfoss proposed a thoughtfully configured system that included automatic balancing valves, floor heating and individual room temperature control.

### Hydronic balancing

To establish the necessary hydronic balance, Danfoss ASV automatic

balancing valves were installed for each apartment. These valves prevent pressure fluctuations and ensure even heat distribution throughout the entire building.

### Different temperatures in each room

In the larger apartments, room temperature can be individually controlled via Danfoss CWD thermostats. The temperature can be separately set for each room, ensuring superb levels of indoor comfort while also saving energy by not heating rooms unnecessarily.

In the smaller apartments, temperature is controlled via one central CWD thermostat. A total of 6,090 thermostats were installed to provide the 2,154 apartments with optimum temperature and comfort control.



Danfoss manifold with RA-G valve and TWA-A actuator. This combination was installed in the smaller apartments to provide central temperature control via a CWD thermostat in the main living room. Individual room controls were installed in the larger apartments.



Danfoss ASV balancing valves and energy meters were installed in the technical room for each group of four apartments.

**Country:** China  
**Building type:** 17 multi family houses  
**Building year:** 2010  
**Size:** 500,000 m<sup>2</sup>  
**Heat emitter:** Floor heating and hydronic balancing  
**Floor heating control type:** Danfoss CWD and FHF-F manifolds  
**Heat source:** District heating  
**Company name:** Xinyuan  
**Company industry:** Real estate company  
**Private consumer name:** Ms. Chen

“We wanted to avoid typical complaints related to poor hydronic balancing while also offering residents optimal comfort. With the help of Danfoss, we fully achieved both these goals.”

Mr. Shengguo Zhu  
Xinyuan real estate





Buying all the products we needed from one supplier provided a sense of reassurance. We basically just added the floor heating pipes.

John Møller-Pedersen  
Constructor



## The advantage of working with a single solution provider

### Optimal indoor climate

The task was to build 18 houses in Denmark with the best possible indoor climate and zero energy consumption. A tough challenge, but very achievable.

### Designing a total solution

The contractor and the manager of the building project put their heads together to work out a solution. A photovoltaic system was chosen as the primary energy source, transforming the sun's rays into electric power. The electric power is then used to operate a heat pump and a heat recovery and ventilation unit. The heat pump provides warm water for the floor heating in the houses.

### Floor heating helps to eliminate heating costs

Energy consumption for heating and ventilating the houses is estimated to be less than 4,000 kWh per year per house,

while the photovoltaic system produces around 6,000 kWh. This means that more energy is produced than is required to operate the heat pump and ventilation unit. Using floor heating in combination with the heat pump is very energy efficient. This is because floor heating requires a lower supply temperature than radiators. For every 1 degree centigrade that the supply temperature can be lowered, heat pump efficiency (COP) improves by 2%.

**Country:** Denmark

**Building type:**  
18 family houses

**Building year:** 2013-2014

**Size:** 104-125 m<sup>2</sup>

**Heat emitter:** Floor heating

**Floor heating type:** CF2<sup>+</sup>

**Heat source:**  
Danfoss heat pump, DHP-AQ

**Company name:**  
Salling Entreprise

**Company industry:**  
Constructor

**Private consumer name:**  
Dorthe Pedersen

### Floor heating with low-energy optimizer

The CF2<sup>+</sup> floor heating system uses a technique called "low energy optimizer" for heat pumps. The technique optimizes floor heating duty cycles so that the heat pump runs more efficiently.



## Individual room controls save energy

### Optimizing living space

What do you do when you want to offer apartment owners maximum living space, valuable energy savings and high heating comfort at the same time? The architects and engineers working on the 'Vadistanbul' project in Istanbul, Turkey, agreed that they could meet all these requirements by using Danfoss floor heating. Floor heating would save precious space in the development's many small apartments while increasing comfort and reducing energy consumption at the same time.

### A prestigious project

The 'Vadistanbul' project is one of Turkey's most prestigious projects. An entire new district will be added to the Istanbul metropolis in three stages. In the first phase, called 'Vadistanbul Teras', 1,111 apartments are being constructed in eight buildings. Subsequent phases will see the construction of a shopping mall, restaurants, a 5-star hotel and a further 1,200 apartments.

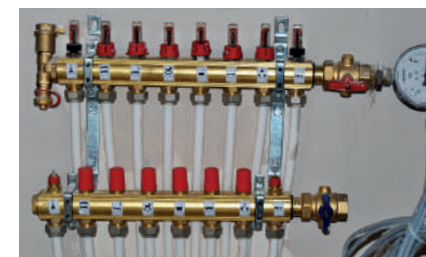

### Individual temperature control

The key to long-term energy savings is the provision of individual temperature control for each room. Heating is provided only when and where it is needed. In addition, floor heating provides such a high level of comfort that the desired temperature can be set 1 or 2 degrees centigrade lower than a comparable radiator heating system. 5% energy is saved for every degree the room temperature is lowered.

### Hydronic balancing

To maximize both energy savings and living comfort, the floor heating system is hydronically balanced. Each group in the floor heating system is pre-set to allow only the required flow to pass through.

### A complete floor heating portfolio

Danfoss provided all necessary floor heating products. In addition, the innovative Danfoss floor panels make the installation of FH PE-RT pipes a simple job.

### Manifolds with both flow meter and pre-setting

The high-quality FHF-F manifolds with flow meter and pre-setting valves create a well-balanced system. TWA-A actuators will be installed to enable the room thermostats to control the temperature in each room.

**Country:** Turkey

**Building type:**  
8 apartment buildings

**Building year:** 2014

**Size:** 1+1 rooms (70 m<sup>2</sup>) up to 5+1 rooms (400 m<sup>2</sup>)

**Heat emitter:** Floor heating

**Floor heating type:** BasicPlus for 600 km of PE-RT pipe

**Floor heating controls:**  
6,342 FH-WT thermostats + 1,179 FH-WC connection boxes control 8.226 TWA-A actuators on FHF-F manifolds

**Heat source:**  
Central heating with a sub-station per apartment

**Company name:**  
Artas-Aydinli-Kelesoglu construction consortium

**Company industry:**  
Construction



Individual room temperature controls will provide future occupants energy savings and a high comfort level.

Mr. Kerim Akinci  
Mechanical engineer





# Pioneering heating controls for decades

Danfoss has been designing and developing heating control systems for more than 80 years. Throughout that time, it has been our goal to continuously innovate, perfect and refine cutting-edge heating and cooling solutions.



First sales of built-in valves (used in floor heating manifolds)

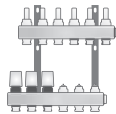

First manifold with Danfoss built-in valves



CF2 wireless room controls introduced with infrared sensor

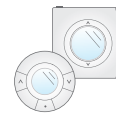

Launch of *Danfoss Link*™ floor heating and radiator thermostat

1943



Mads Clausen designs the world's first radiator thermostat

1982



World's first wireless room control for floor heating introduced

1996



Danfoss acquires PentaCom floor heating and launches its own TWA

1998



Danfoss acquires Jupiter floor heating

2002



Launch of Danfoss *Icon*™ Floor Heating Controls

2005



2007

2011

2017

## Danfoss A/S

Heating Segment • [heating.danfoss.com](http://heating.danfoss.com) • +45 7488 2222 • E-Mail: [heating@danfoss.com](mailto:heating@danfoss.com)

Danfoss can accept no responsibility for possible errors in catalogues, brochures and other printed material. Danfoss reserves the right to alter its products without notice. This also applies to products already on order provided that such alterations can be made without consequential changes being necessary in specifications already agreed. All trademarks in this material are property of the respective companies. Danfoss and all Danfoss logotypes are trademarks of Danfoss A/S. All rights reserved.